

## 36" Series 9 with Infrared Sear Burner, LPG

Series 9

Stainless Steel | LPG



This Series 9 built-in 36" grill is designed for premium outdoor kitchens and will take your outdoor cooking experience to the next level.

- Infrared sear burner for incredibly fast searing up to 24,000 BTU/hr
- Cater for a crowd with the secondary cooking surface
- Build into an outdoor BBQ island, or add a cart for a freestanding grill
- U-burners deliver 25,000 BTU/hr total power per burner with precise heat control from 300°F to 1100°F

## DIMENSIONS

Height	27 1/4 "
Width	35 15/16 "
Depth	26 7/8 "

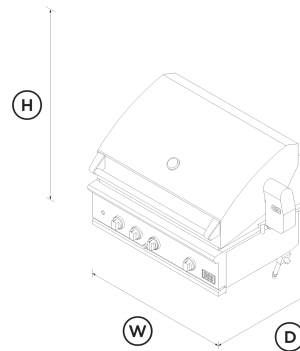

## FEATURES & BENEFITS

### The Perfect Sear

A dedicated searing zone with a dynamic infrared burner allows you to experience a new level of versatility, using a range of cooking methods. The improved dual rail design offers increased control and faster heating, so you can achieve the perfect sear every time.

### Charcoal Smoker Tray

Enjoy a smoky barbecue flavour with the ease of instant gas flame ignition. Grill directly on the cooking grate or add wood chips for extra smoke. A W-shaped tray with adjustable vents helps the charcoal last longer.

### Heavy-Duty Infrared Rotisserie

An infrared rotisserie burner provides controlled searing heat up to 14,000BTU. Perfect for entertaining, the heavy-duty motor can easily turn a 50lb load. The rotisserie rod is conveniently stored under the drip pan handle.

### Intuitive Lighting

Brilliant 12-volt lighting safely illuminates the entire grilling surface when you open the lid. Ideal for night-time cooking, the bezel dial lighting glows white when the grill is on, and orange when the gas and grill are in use.

### Easy Lifting Hood

The hood can be opened using one hand for better access and visibility when cooking. You can easily accommodate larger food loads with extra space under the hood.

### Extra Cooking Area

Effortlessly cook for a crowd with a secondary cooking space. You can fit a grill pan for slow cooking, roasting and making sauces, or to keep food warm after searing.

### Grease Management System™

Our Grease Management System™ reduces flare-ups by channelling grease and oils away from the burner flames during grilling.

## SPECIFICATIONS

### Accessories (sold separately)

6" accessory storage	ASE6-36
Built-in grill cover	ACBI-36E

Griddle plate	<b>BGC-GP</b>
Insulated jacket	<b>BGA36-IJS (optional)</b>
Insulated jacket (with storage accessory unit)	<b>BGA42-IJS (optional)</b>
On cart grill cover	<b>ACC-36E</b>
Optional cart mount	<b>CAD-36E</b>

**Burners**

Number of U-burners	<b>2</b>
Sear burner zone	<b>•</b>

**Cooking Surface Area**

Primary cooking area	<b>630 sq.in.</b>
Secondary cooking area	<b>534 sq.in.</b>
Total cooking area	<b>1164 sq.in.</b>

**Features**

Double sided grilling grates	<b>flat and angled position</b>
Full charcoal burner/smoker	<b>•</b>
Full surface searing	<b>•</b>
Grease management system™	<b>•</b>
Hood temperature gauge	<b>•</b>
Ignition system	<b>Hot surface</b>
Metal dials	<b>•</b>
Rotisserie	<b>•</b>
Secondary cooking	<b>2-level racks and tray</b>
Wireless temperature sensor compatible	<b>•</b>

<b>Finish</b>	
Material	<b>304 grade stainless steel</b>
Weather resistant	<b>•</b>

**Gas Requirements**

1/2" NPT male	<b>•</b>
Gas type	<b>LPG</b>
LP hose with regulator and Type 1 connector	<b>•</b>
Operational pressure	<b>11" W.C.</b>
Supply pressure	<b>12" to 14" W.C.</b>

**Installation Dimensions**

Cutout depth (proud)	<b>22 3/4 "</b>
Cutout height (proud)	<b>10 1/8 "</b>
Cutout width (proud)	<b>34 1/2 "</b>
Insulated jacket for proud cut-out	<b>Varies - check manual</b>

**Performance**

Rotisserie burner power	<b>14000 BTU</b>
Sear burner power	<b>24000 BTU</b>
Total Power	<b>88000 BTU</b>
U-burner power	<b>25000 BTU</b>
Weight rotisserie can handle	<b>50 lbs</b>

**Power Requirements**

















Rotisserie power supply	<b>120V 60Hz</b>
-------------------------	------------------

Supply frequency	<b>60 Hz</b>
Supply voltage	<b>120 V</b>

SKU	<b>71594</b>
-----	--------------

The product dimensions and specifications in this page apply to the specific product and model. Under our policy of continuous improvement, these dimensions and specifications may change at any time. You should therefore check with Fisher & Paykel's Customer Care Centre to ensure this page correctly describes the model currently available. © DCS by Fisher & Paykel Appliances Limited 2020

**Other product downloads available at [dcsappliances.com](https://dcsappliances.com)**

-  2D-DWG Grill
-  2D-DWG Grill with Storage Unit
-  2D-DWG Grill with Storage Unit and Insulated Jacket
-  2D-DWG Grill with Insulated Jacket
-  2D-DXF Grill
-  2D-DXF Grill with Storage Unit
-  2D-DXF Grill with Storage Unit and Insulated Jacket
-  2D-DXF Grill with Insulated Jacket
-  Data Sheet Grill with ASE636 Storage Unit
-  Data Sheet Grill with BGA36-IJS Insulated Jacket
-  Installation Guide Grill EN
-  Installation Guide Grill on Cart EN
-  Guide d'installation FR
-  Installation Guide Grill on Cart FR
-  Guía de instalación SP
-  Installation Guide Grill on Cart SP
-  Planning Guide EN - Professional Grills Series 9 Outdoor Kitchen

- ↓ [Planning Guide FR - Professional Grills Series 9 Outdoor Kitchen](#)
- ↓ [Planning Guide SP - Professional Grills Series 9 Outdoor Kitchen](#)
- ↓ [Revit-18 Grill](#)
- ↓ [Revit-18 Grill with Storage Unit](#)
- ↓ [Rhino-5 Grill](#)
- ↓ [Rhino-5 Grill with Storage Unit](#)
- ↓ [Rhino-5 Grill with Storage Unit and Insulated Jacket](#)
- ↓ [Rhino-5 Grill with Insulated Jacket](#)
- ↓ [Service and Warranty](#)
- ↓ [Sketchup-8 Grill](#)
- ↓ [Sketchup-8 Grill with Storage Unit](#)
- ↓ [Sketchup-8 Grill with Storage Unit and Insulated Jacket](#)
- ↓ [Sketchup-8 Grill with Insulated Jacket](#)
- ↓ [User Guide Grill EN](#)
- ↓ [Guide d'utilisation FR](#)
- ↓ [Guía del usuario SP](#)

### A PEACE OF MIND SALE

24 Hours 7 Days a Week Customer Support

T 1.888.936.7872 W [www.dcsappliances.com](http://www.dcsappliances.com)