

# SIDE SHELF (CAD-SK 70853)

## INSTALLATION INSTRUCTIONS

### IMPORTANT:

Read all instructions before you begin. Do not jump ahead or skip any step.

### CAUTION:

Some parts have sharp edges; care must be taken when handling the various components to avoid injury. Be sure to use adequate manpower to assemble and install the side shelf to prevent personal injury or damage to the unit.

*NOTE: Avoid using side shelf to move cart. Push or pull cart by grasping corners of grill head. Never attempt to move a hot grill. Allow unit to cool before touching.*

## GETTING STARTED





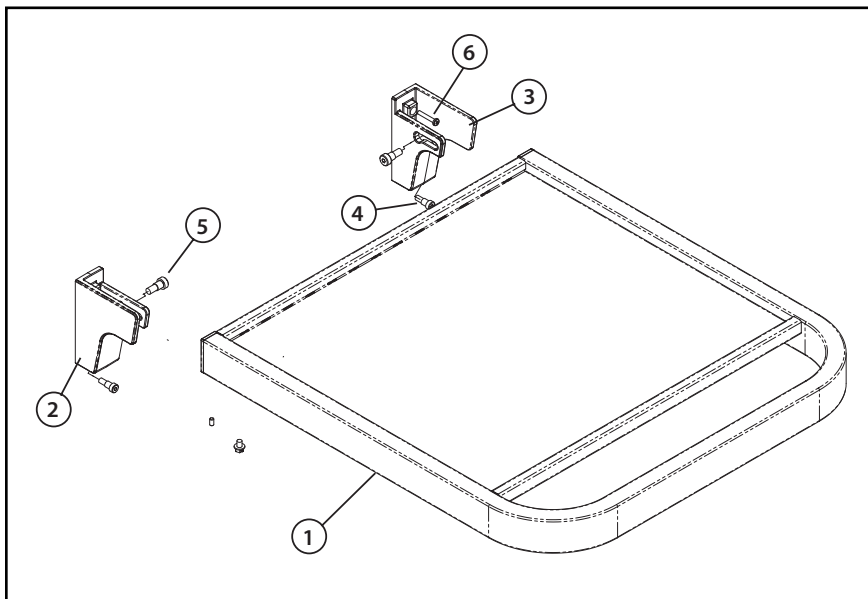

- Remove packaging.

### Contents Included:

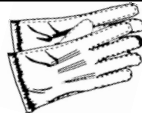
Your side shelf is packaged in one box. The box contains your side shelf, brackets, and installation hardware.



### Tools Required:

	(optional) Work Gloves
	Eye Protection
	Power Screwdriver or Variable Speed Drill with Phillips - tip #2 Attachment
	5/32" Allen Wrench
	3/32" Allen Wrench
	3/16" Allen Wrench

Item No.	Description	Quantity
1	Shelf	1
2	Bracket, Shelf-left	1
3	Bracket, Shelf-right	1
4	Bolt Shoulder, 5/16 x 1/4-20	2
5	Shoulder Bolt, 3/8 x 3/8 x 5/16-18	2
6	Screw, 10-24 X 1-1/8	2

## Attach Side Shelf Accessory on Either Side

**NOTE:** Side shelf Model CAD-SK can be installed with the head already on the cart.

1. Screw shoulder bolts (2) into the bottom screw holes on the side of the cart (Fig. 01 and 02). Tighten with 5/32 Allen wrench.

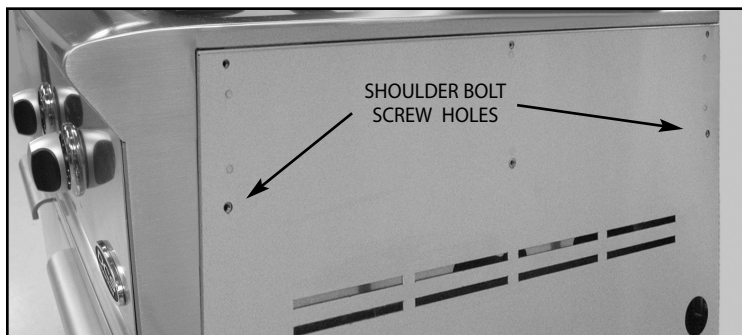

Fig. 01

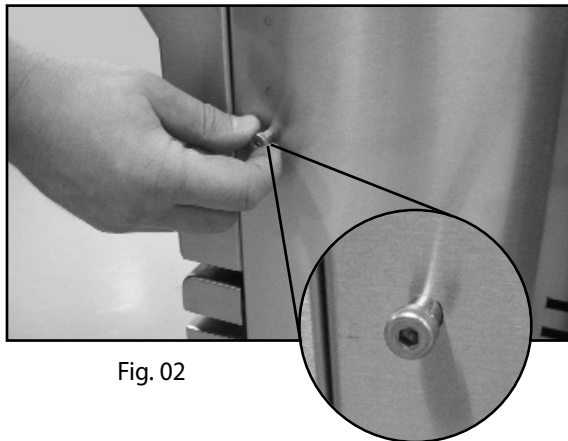

Fig. 02

2. Slide left and right side shelf brackets over the shoulder bolt (Fig. 03) and install top screw attaching the side shelf brackets onto the cart (Fig. 04). Tighten with Phillips screwdriver.

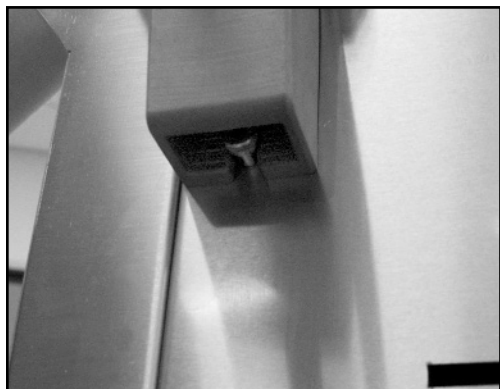

Fig. 03

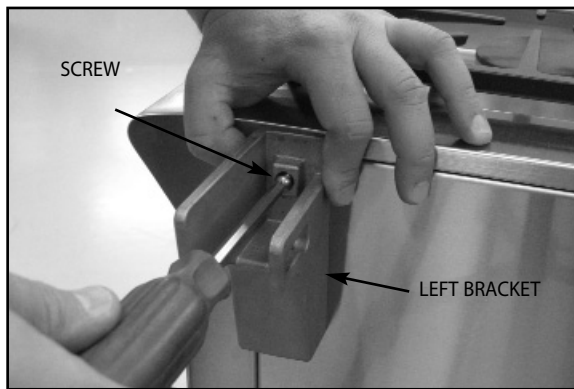

Fig. 04

3. Holding the side shelf, install 2 shoulder bolts (3/8 shoulder bolt) through the slots on the side shelf brackets into the threaded holes on the side of the side shelf tray (Fig. 05). Tighten with a 3/16 Allen wrench (Fig. 06).



Fig. 05

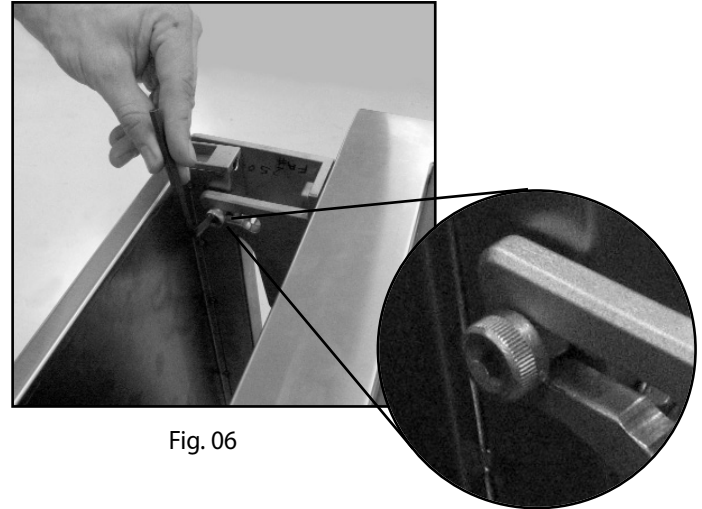

Fig. 06

4. Locate the cart on flat level ground before attempting to level the side shelves. Place shelf in the up position and check that it is level.

If the shelf is not level, adjust side shelf set screws. The set screws can be adjusted using a 3/32 Allen wrench (Fig. 07). Turn the Allen wrench clockwise to raise the shelf. Turn 1/4 turn and review to see if the shelf is level. The set screws in the left and right bracket should be adjusted equally to ensure the shelf sits level (Fig. 08).

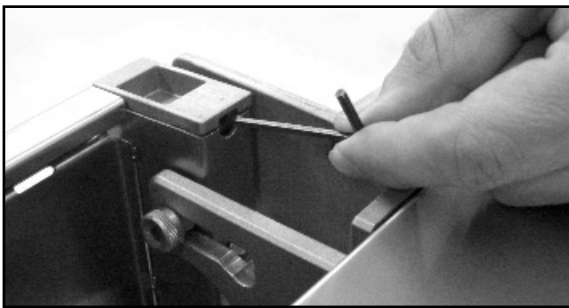

Fig. 07

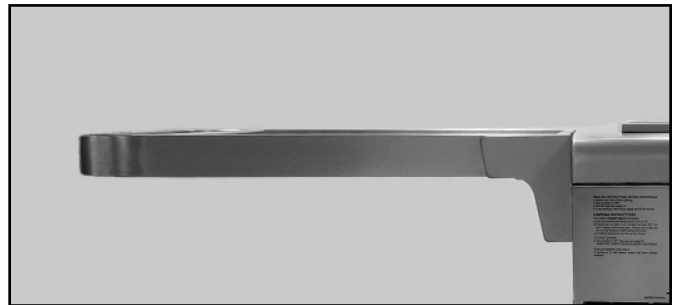

Fig. 08



Fig. 09

Optional wood cutting board (model # CAD-WBC, 70861) shown in Figure 09 can be purchased as an accessory from Customer Care at (888) 281-5698.



---

Quality provided by Fisher & Paykel Appliances Inc.

---

Fisher & Paykel Appliances, Inc.  
5900 Skylab Road, Huntington Beach, CA 92647  
Customer Care: 888.281.5698 • Fax: 714.372.7003  
[www.dcsappliances.com](http://www.dcsappliances.com)

P/N 240560 RA 05/07